

设计:
工艺:
审核:
批准:

电路图

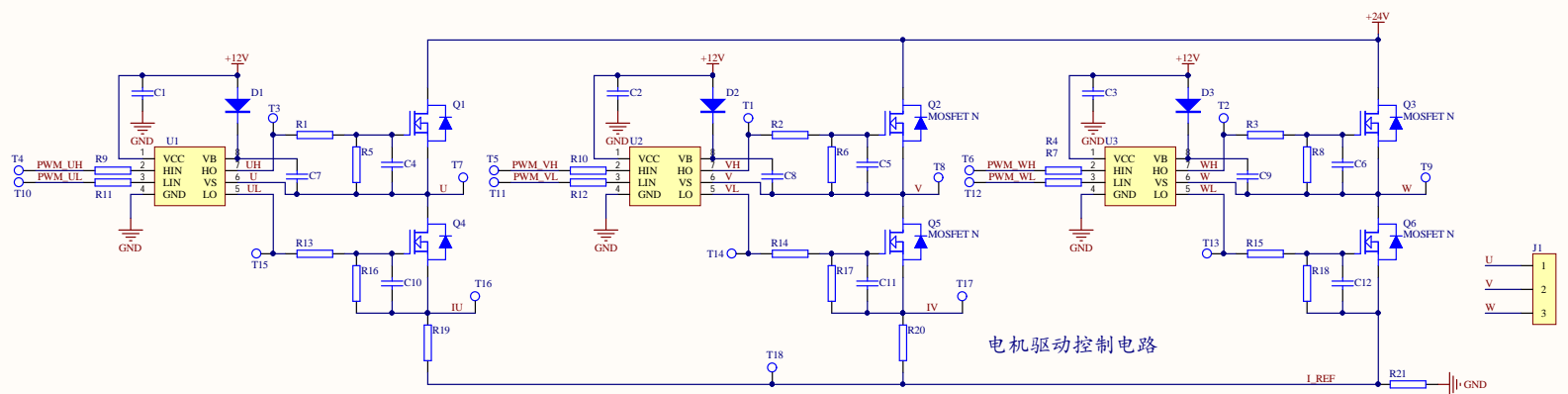

电机驱动控制电路

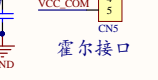
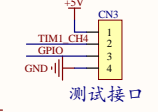
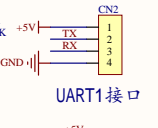
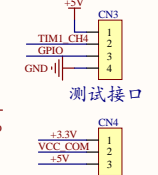
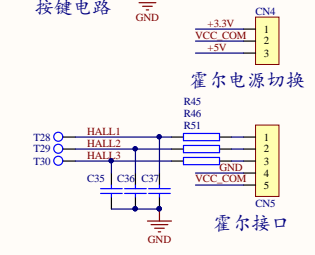
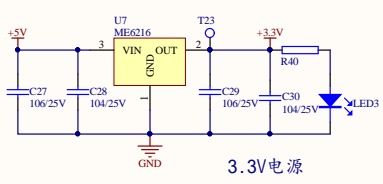
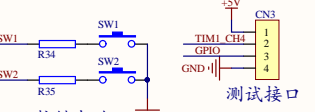
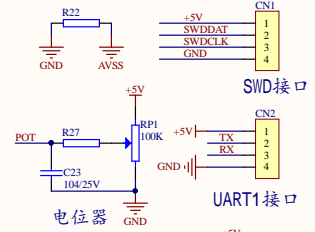
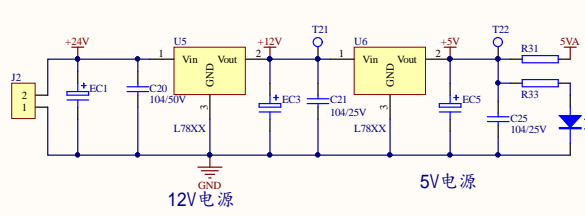
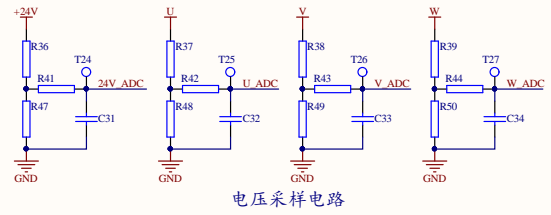
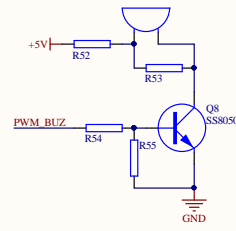
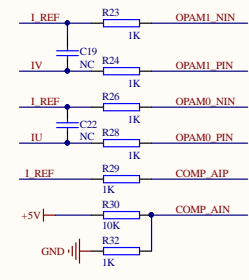
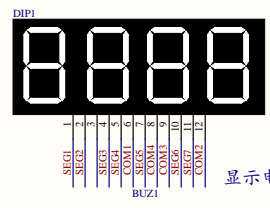
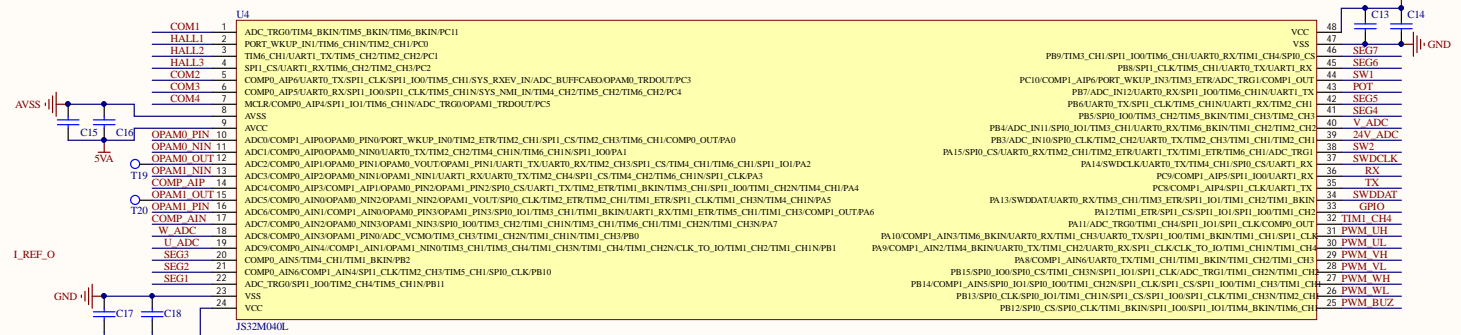

阶段标记
比例
第 页
共 页
编码: